

PLANS TECHNIQUES

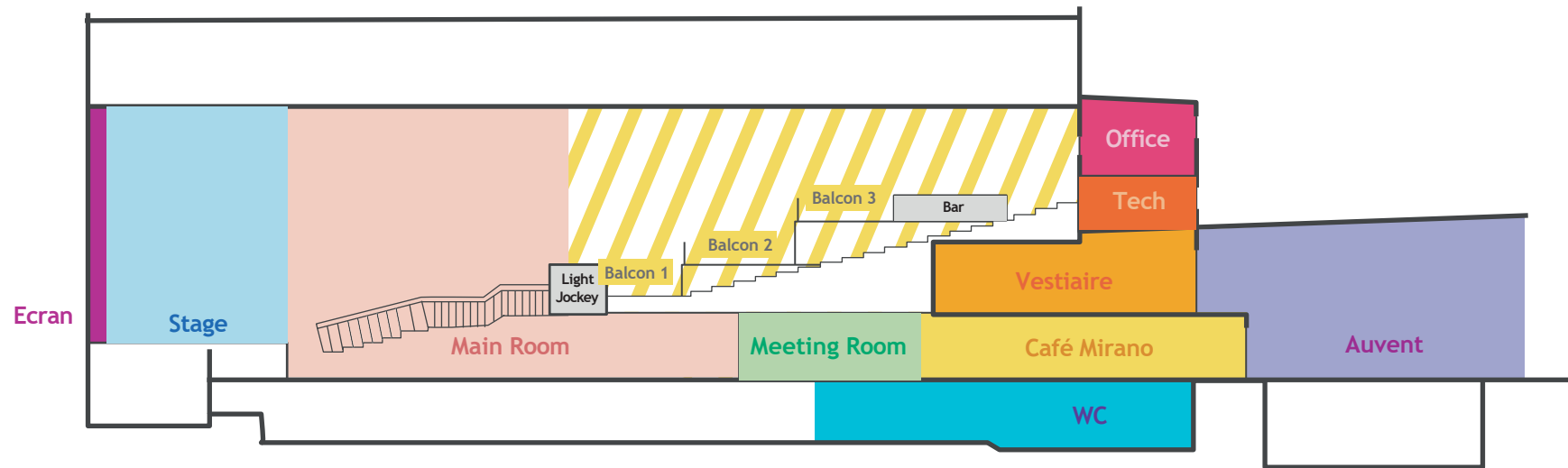

Member of
ART BLANC
UNIQUE VENUES

ELEVATION



REZ-DE-CHAUSSÉE

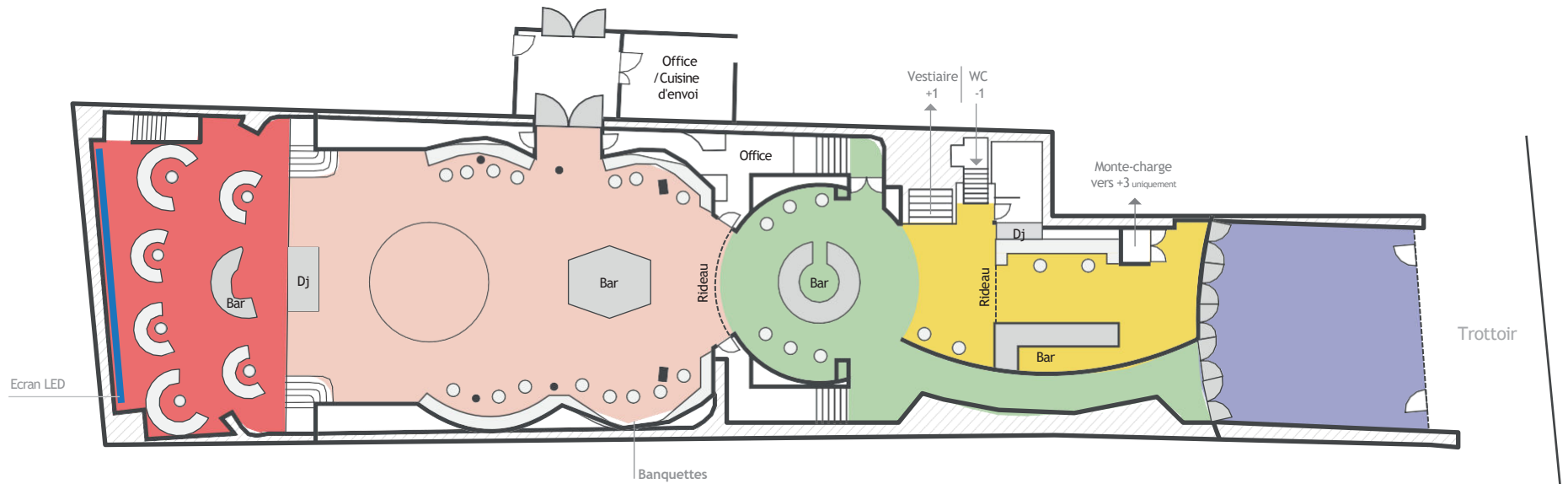

VIP / Stage
5 m²

Main Room
20 .50 m²

Meeting Room
5 m²

Café Mirano
G4m²

Auvent
83 m²



NIVEAU +1

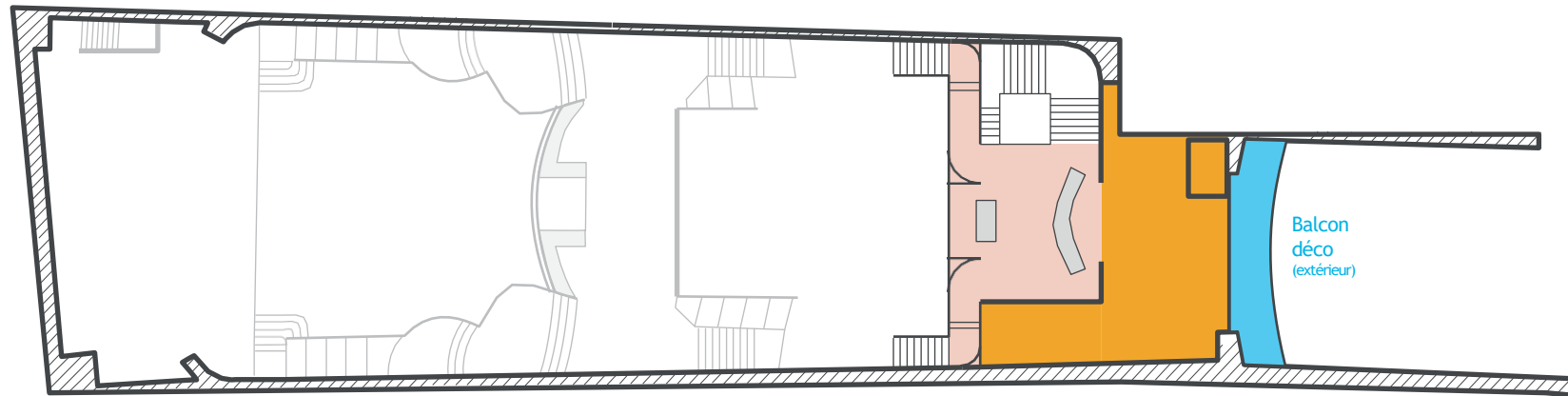

Lobby Vestiaire
7.50 m²



BALCONS

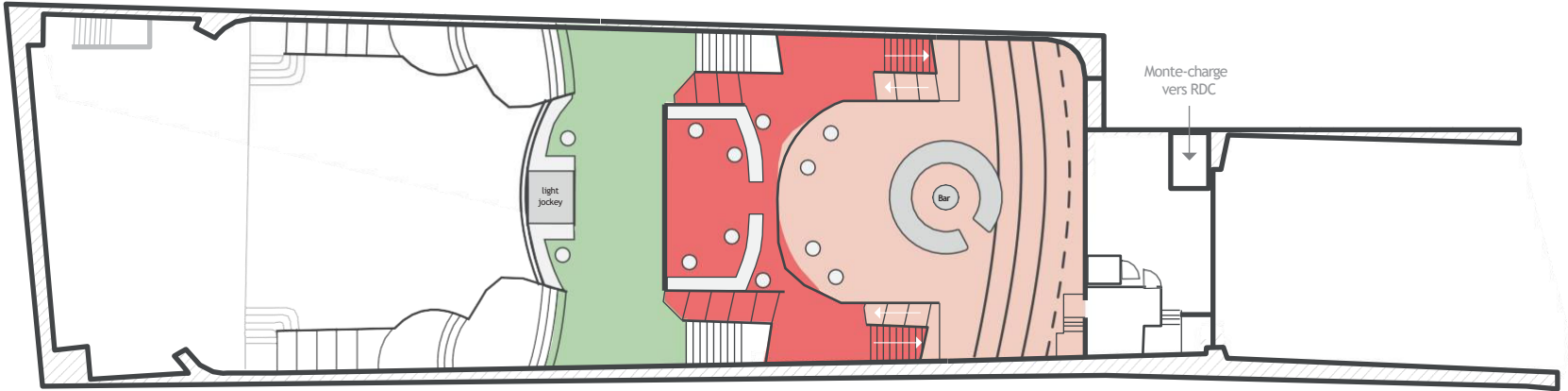

Balcon 1
niveau +1

G7.50 m²

Balcon 2
niveau +2

35 m²

Balcon 3
niveau +3

G1 m²



SOUS-SOL

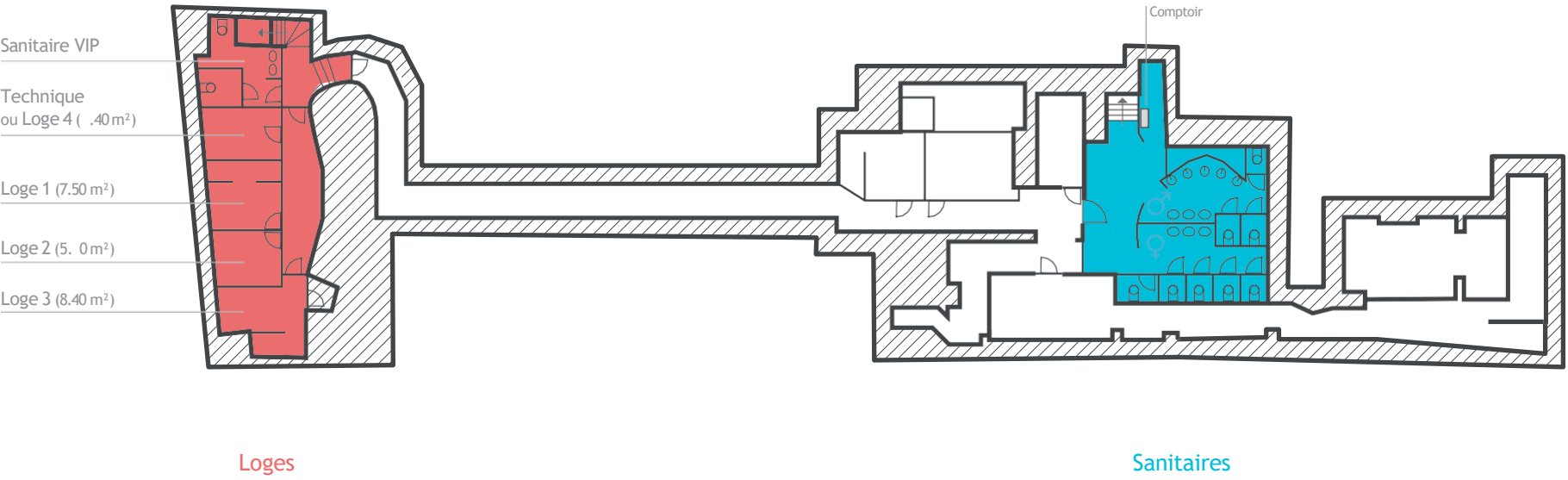

PLAN D'ACCÈS

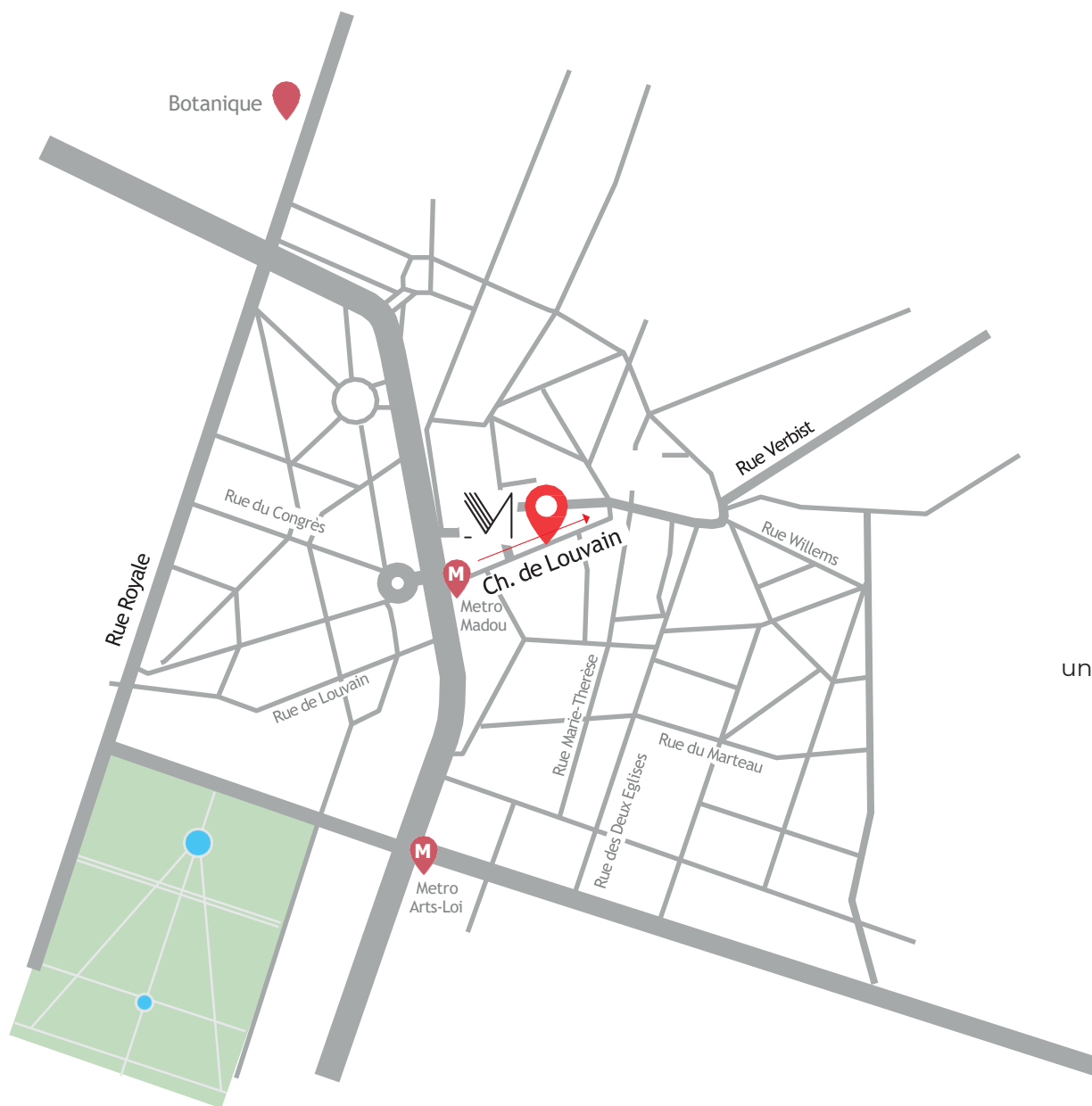

La Chaussée de Louvain est en sens unique de 7 à 1H du lundi au vendredi

